



MicroScanner²TM

Cable Verifier

Getting Started Guide

PN 2739668 (English)

January 2007

©2007 Fluke Corporation. All rights reserved. Printed in China.
All product names are trademarks of their respective companies.

LIMITED WARRANTY AND LIMITATION OF LIABILITY

Fluke Networks guarantees this product to be free from defects in material and workmanship for one year from the date of purchase. Parts, accessories, product repairs and services are warranted for 90 days, unless otherwise stated. Ni-Cad, Ni-MH and Li-Ion batteries, cables or other peripherals are all considered parts or accessories.

This warranty does not cover damage from accident, neglect, misuse, alteration, contamination, or abnormal conditions of operation or handling. Resellers are not authorized to extend any other warranty on Fluke Networks' behalf.

To obtain service during the warranty period, contact your nearest Fluke Networks authorized service center to obtain return authorization information, then send your defective product to that Service Center with a description of the problem.

THIS WARRANTY IS YOUR ONLY REMEDY. NO OTHER WARRANTIES, SUCH AS FITNESS FOR A PARTICULAR PURPOSE, ARE EXPRESSED OR IMPLIED. FLUKE NETWORKS IS NOT LIABLE FOR ANY SPECIAL, INDIRECT, INCIDENTAL OR CONSEQUENTIAL DAMAGES OR LOSSES, ARISING FROM ANY CAUSE OR THEORY.

Since some states or countries do not allow the exclusion or limitation of an implied warranty or of incidental or consequential damages, this limitation of liability may not apply to you.

4/04

Fluke Networks
PO Box 777
Everett, WA 98206-0777
USA

MicroScanner² Cable Verifier

Accessing the Users Manual

This guide provides basic information to help you get started using the tester. For additional information, see the *MicroScanner² Cable Verifier Users Manual* on the Product CD.

Safety

⚠ Warning ⚡

To avoid possible fire, electric shock, personal injury, damage to equipment, or inaccurate test results, read the safety information in the *MicroScanner² Cable Verifier Users Manual* before using the tester.

Keys



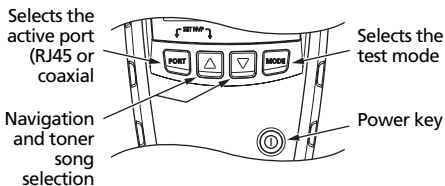

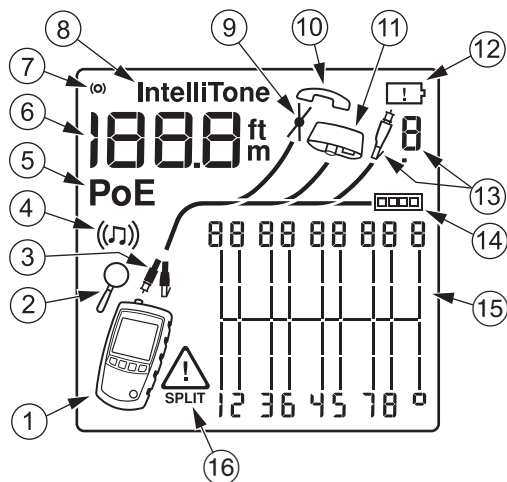

Combinations of keys provide additional functions. See the Users Manual.





Display Features





egs02.eps

- 1 Tester icon
- 2 Detail screen indicator. To see detail screens, press  or  during a cable test; then press  or .
- 3 Indicates which port is active, the RJ45 port () or the coaxial port ()
- 4 Tone mode indicator
- 5 Power over Ethernet mode indicator
- 6 Numeric display with feet/meters indicator
- 7 Test activity indicator
- 8 Appears when the toner is in IntelliTone mode
- 9 Indicates a short on the cable

- ⑩ Telephone voltage indicator.  and  appear in the wiremap diagram over the positive (tip) and negative (ring) wires.
- ⑪ Indicates a wiremap adapter is connected to the far end of the cable
- ⑫ Low battery indicator
- ⑬ Indicates an ID locator is connected to the far end of the cable and shows the locator's number
- ⑭ Ethernet port indicator
- ⑮ Wiremap diagram. The rightmost segments indicate the shield.
- ⑯ The  indicates a fault or high voltage on the cable. **SPLIT** appears when the fault is a split pair.

Changing the Length Units

- 1 Hold down  and  while turning on the tester.
- 2 Press  to switch between meters and feet.



Auto Shutoff

The tester turns off after 10 minutes if no keys are pressed and nothing changes at the tester's connectors.

Testing Cabling

Note

A wiremap adapter or remote ID locator must be connected to the end of the cabling for the wiremap to be completely verified.

- 1 Press **ⓘ** to turn on the tester.
- 2 Press **PORT** to switch between twisted pair () and coaxial () modes.
- 3 Connect as shown in the following figures.

Note

*If the **PoE** indicator appears, see page 7.*

Connecting to Twisted Pair Network Cabling

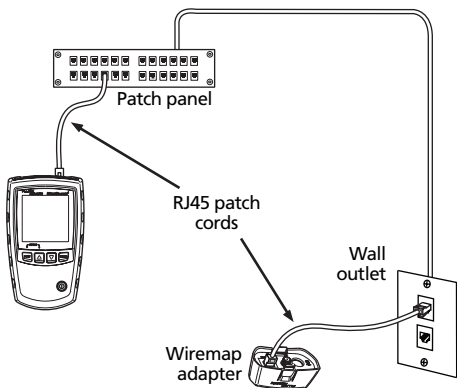

egs03.eps

Connecting to a Bus Topology

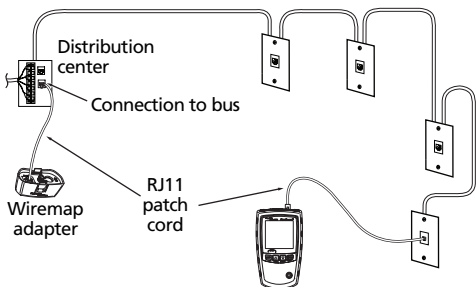

Note: Locations of the tester and wiremap adapter may be swapped.

egs17.eps

Connecting to a Star Topology

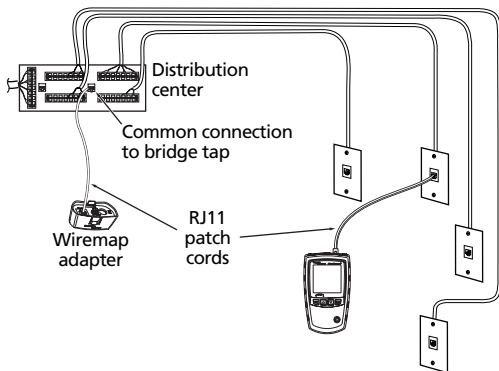

Note: For a correct length reading, connect the tester and wiremap adapter as shown. See the Users Manual for details.

egs16.eps

Connecting to Coaxial Cabling

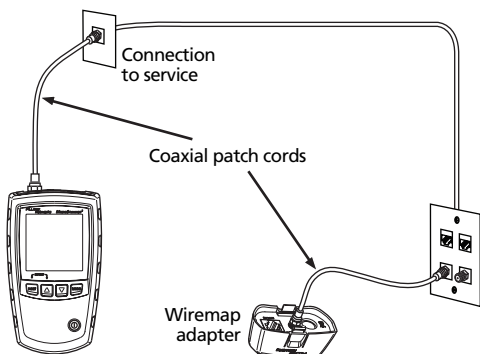

egs19.eps

Using the Toner

- 1 Press **PORT** to select twisted pair (🔌) or coaxial (🔌) cable.
- 2 Connect the tester to the cable.
- 3 Press **MODE** until ((🎵)) appears on the display.
- 4 To cycle through the IntelliTone and analog toner songs, press **▲** or **▼**.
- 5 Use an optional IntelliTone probe or an analog probe to locate the cable.

Notes

*If the **PoE** indicator appears, see page 7.*

Auto shutoff is disabled in toner mode.

Detecting Power Over Ethernet

The tester can detect PoE voltages from active 802.3af sources.

To select PoE mode, press  until **PoE** appears on the display.

In PoE mode, the tester solicits PoE power on pairs 1,2-3,6 and 4,5-7,8. The tester may activate a PoE source and will not be damaged by PoE power.

If PoE power is detected, **PoE** appears above the powered pairs. The **PoE** may blink as the PoE source turns the power on and off.

In twisted pair test mode, a flashing **PoE** mode indicator means that PoE power may be available. To verify the presence of a PoE source, switch the tester to PoE mode.

Replacing the Batteries

The batteries last for about 20 hours of typical use.

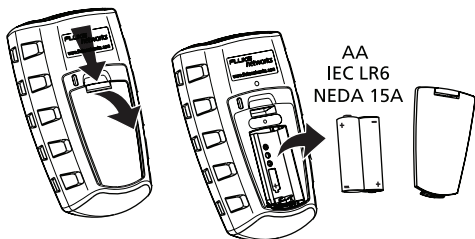

Contacting Fluke Networks



www.flukenetworks.com



support@flukenetworks.com



+1-425-446-4519

- Australia: 61 (2) 8850-3333 or 61 (3) 9329 0244
- Beijing: 86 (10) 6512-3435
- Brazil: 11 3044 1277
- Canada: 1-800-363-5853
- Europe: +44-(0)1923 281 300
- Hong Kong: 852 2721-3228
- Japan: 03-3434-0510
- Korea: 82 2 539-6311
- Singapore: +65-6799-5566
- Taiwan: (886) 2-227-83199
- USA: 1-800-283-5853

Visit our website for a complete list of phone numbers.